

High Spectrum Efficiency and Low BER of Massive MIMO System using Spectrum Sensing Cognitive Radio Network

Rishika Dubey^{1*}, Vineeta Saxena Nigam²

^{1,2}Department of Electronics and Communication Engineering, UIT-RGPV, Bhopal

Corresponding Author: rishika.dubey14@gmail.com

DOI: <https://doi.org/10.26438/ijcse/v7i7.287291> | Available online at: www.ijcseonline.org

Accepted: 11/Jul/2019, Published: 31/Jul/2019

Abstract— In a cellular network, the demand for high throughput and reliable transmission is increasing in large scale. One of the architectures proposed for 5G wireless communication to satisfy the demand is Massive MIMO system. The massive system is equipped with the large array of antennas at the Base Station (BS) serving multiple single antenna users simultaneously i.e., number of BS antennas are typically more compared to the number of users in a cell. This additional number of antennas at the base station increases the spatial degree of freedom which helps to increase throughput, maximize the beamforming gain, simplify the signal processing technique and reduces the need of more transmit power. The advantages of massive MIMO can be achieved only if Channel State Information (CSI) is known at BS uplink and downlink operate on orthogonal channels. The studied of non-cooperative cognitive radio network based massive MIMO systems is present in this paper.

Keywords: - Spectrum Sensing, Cognitive Radio, Non-Cooperative Communication, Massive MIMO

I. INTRODUCTION

The demand for wireless throughput has grown exponentially in the past few years, with the increase in a number of wireless devices and number of new mobile users [1]. The throughput is the product of Bandwidth (Hz) and Spectral efficiency (bits/s/Hz). To increase the throughput, either Bandwidth or Spectral efficiency has to be increased. Since increasing the Bandwidth is a costly factor, the spectral efficiency has to be taken into consideration. It can be increased by using multiple antennas at the transmitter and receiver. Multiple-Input Multiple Output (MIMO) antennas enhance both communication reliability as well as the capacity of communication (by transmitting different data in different antennas).

Generally MIMO systems are divided into two categories: Point-to-Point MIMO and Multi User - MIMO (MU-MIMO) [2], [3]. In Point-to-Point MIMO, both the transmitter and receiver are equipped with multiple antennas. The performance gain can be achieved by using the techniques such as beamforming and spatial multiplexing of several data streams. On the other hand, in MU-MIMO, the wireless channel is spatially shared among the users. The users in the cell transmit and receive data without joint encoding and joint detection among them. The Base Station (BS) communicates simultaneously with all the users, by exploiting the difference in spatial signatures at the BS antenna array. MIMO systems are incorporated in several

new generation wireless standards like LTE - Advanced, Wireless LAN etc. The main challenge in MU-MIMO system is the interference between the co-channel users. Hence, complex receiver technique has to be used, to reduce the co-channel interference.

The demand for wireless throughput has grown exponentially in the past few years, with the increase in a number of wireless devices and number of new mobile users. The throughput is the product of Bandwidth (Hz) and Spectral efficiency (bits/s/Hz) [1]. To increase the throughput, either Bandwidth or Spectral efficiency has to be increased. Since increasing the Bandwidth is a costly factor, the spectral efficiency has to be taken into consideration. It can be increased by using multiple antennas at the transmitter and receiver. Multiple-Input Multiple Output (MIMO) antennas enhance both communication reliability as well as the capacity of communication (by transmitting different data in different antennas). Generally MIMO systems are divided into two categories: Point-to-Point MIMO and Multi User - MIMO (MU-MIMO) [2], [3]. In Point-to-Point MIMO, both the transmitter and receiver are equipped with multiple antennas. The performance gain can be achieved by using the techniques such as beamforming and spatial multiplexing of several data streams. On the other hand, in MU-MIMO, the wireless channel is spatially shared among the users. The users in the cell transmit and receive data without joint encoding and joint detection among them. The Base Station (BS) communicates

simultaneously with all the users, by exploiting the difference in spatial signatures at the BS antenna array. MIMO systems are incorporated in several new generation wireless standards like LTE - Advanced, Wireless LAN etc. The main challenge in MU-MIMO system is the interference between the co-channel users. Hence, complex receiver technique has to be used, to reduce the co-channel interference. In [4], it is shown that by using an infinite number of antennas at the BS in comparison with the number of users in the cell, the random channel vectors between users and the BS become pair-wise orthogonal. By introducing more antennas at the BS, the effects of uncorrelated noise and intra cell interference disappear and small scale fading is averaged out. Hence, simple matched filter processing at BS is optimal. MU-MIMO system with hundreds of antenna at the BS which serves many single antenna user terminals simultaneously at same frequency and time is known as Massive MIMO system or large antenna array MU-MIMO system [5],[6]. One of the architectures proposed for 5G wireless communication is the massive MIMO system in which BS is equipped with a large number of antennas and serves multiple single antenna user terminals as shown in Fig 1.

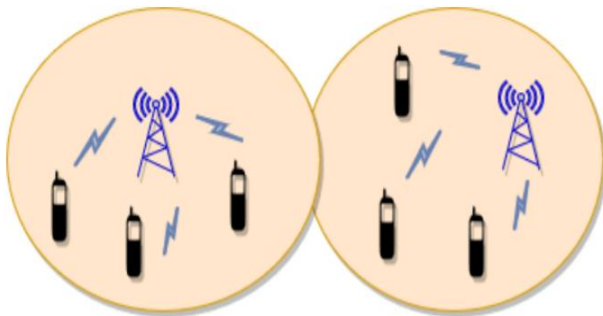

Figure 1: Multi-cell Massive MIMO System

Advantages of Massive MIMO System:-

High energy efficiency: If the channel is estimated from the uplink pilots, then each user's transmitted power can be reduced proportionally to $1/\sqrt{M}$ considering M is very large. If perfect Channel State Information (CSI) is available at the BS, then the transmitted power is reduced proportionally to $1/M$ [7]. In the downlink case, the BS can send signals only in the directions where the user terminals are located. By using the Massive MIMO, the radiated power can be reduced achieving high energy efficiency.

- **Simple signal processing:** Using an excessive number of BS antennas compared to users lead to the pair-wise orthogonality of channel vectors. Hence, with simple linear processing techniques both the effects of inter user interference and noise can be eliminated.
- **Sharp digital beamforming:** With an antenna array, generally analog beamforming is used for steering by adjusting the phases of RF signals. But in the case of

Massive MIMO, beamforming is digital because of linear precoding. Digital beamforming is performed by tuning the phases and amplitudes of the transmitted signals in baseband. Without steering actual beams into the channels, signals add up in phase at the intended users and out of phase at other users. With the increase in a number of antennas, the signal strength at the intended users gets higher and provides low interference from other users. Digital beamforming in massive MIMO provides a more flexible and aggressive way of spatial multiplexing. Another advantage of digital beamforming is that it does not require array calibration since reciprocity is used.

- **Channel hardening:** The channel entries become almost deterministic in case of Massive MIMO, thereby almost eliminating the effects of small scale fading. This will significantly reduce the channel estimation errors.
- **Reduction of Latency:** Fading is the most important factor which impacts the latency. More fading will leads to more latency. Because of the presence of Channel hardening in Massive MIMO, the effects of fading will be almost eliminated and the latency will be reduced significantly.
- **Robustness:** Robustness of wireless communications can be increased by using multiple antennas. Massive MIMO have excess degrees of freedom which can be used to cancel the signal from intentional jammers.
- **Array gain:** Array gain results in a closed loop link budget enhancement proportional to the number of BS antennas.
- **Good Quality of Service (QoS):** Massive MIMO gives the provision of uniformly good QoS to all terminals in a cell because of the interference suppression capability offered by the spatial resolution of the array. Typical baseline power control algorithms achieve max-min fairness among the terminals.
- **Autonomous operation of BS's:** The operation of BS's is improved because there is no requirement of sharing Channel State Information (CSI) with other cells and no requirement of accurate time synchronization.

II. MASSIVE MIMO CONCEPT

A single cell massive MIMO system where BS is equipped with a large number of antennas (M) and serving multiple single antenna User Terminals (K), where ($M > K$) is shown in Figure 2. The channel matrix of massive MIMO system is modeled as the product of small scale fading matrix and a diagonal matrix of geometric attenuation and log-normal shadow fading. The channel coefficient between the m^{th} antenna of the BS and the k^{th} user h_{mk} is represented by

$$h_{mk} = g_{mk} \sqrt{\beta_k} \quad (1)$$

Where g_{mk} is the small scale fading coefficient. $\sqrt{\beta_k}$ models the geometric attenuation and shadow fading, which is

assumed to be independent over m and to be constant over many coherence time intervals and known a priori. This assumption is reasonable since the distance between the users and base station is much larger than the distance between the antennas.

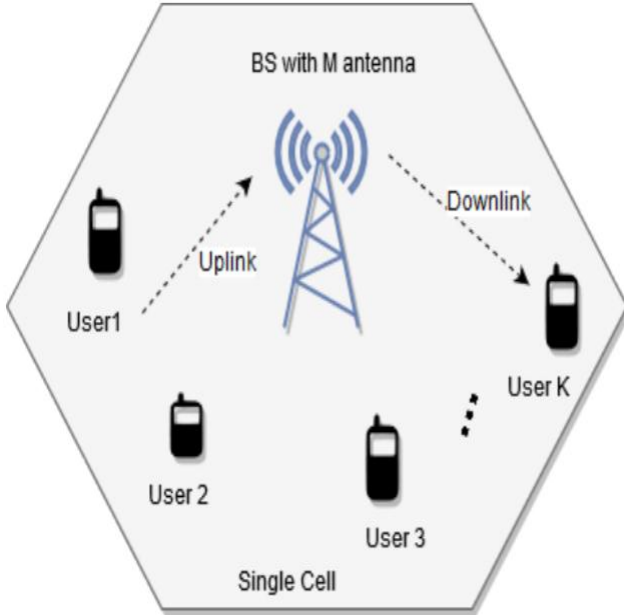

Figure 2: Single cell Massive MIMO System

III. PROPOSED METHODOLOGY

The execution of framework model in MATLAB programming, with the principle square depicted beneath. We created an arbitrary twofold sign in sequential way. To examine a sign in the sequential to parallel converter at that point connected IFFT (backwards quick fourier change) and convert it from parallel to sequential OFDM signal. The OFDM sign is include cyclic prefix (CP) on the grounds that the expel impedance between OFDM images. We at that point feed this sign through an Additive White Gaussian Noise (AWGN) channel. At the recipient site, the OFDM sign is CP expelled and sign changed over from sequential to parallel at that point connected FFT (quick fourier change). Gotten the yield of FFT signal at that point sign changed over from parallel to sequential converter to every image for investigation in the recurrence area is gotten. After demodulation the sign is cross corresponded with that a period moved in demodulation signal.

At long last, the got sign is contrasted with limit esteem (λ) following the SNR or decides if the sign is missing or present; if the got sign is more prominent than the edge esteem, there will be identification, generally not:

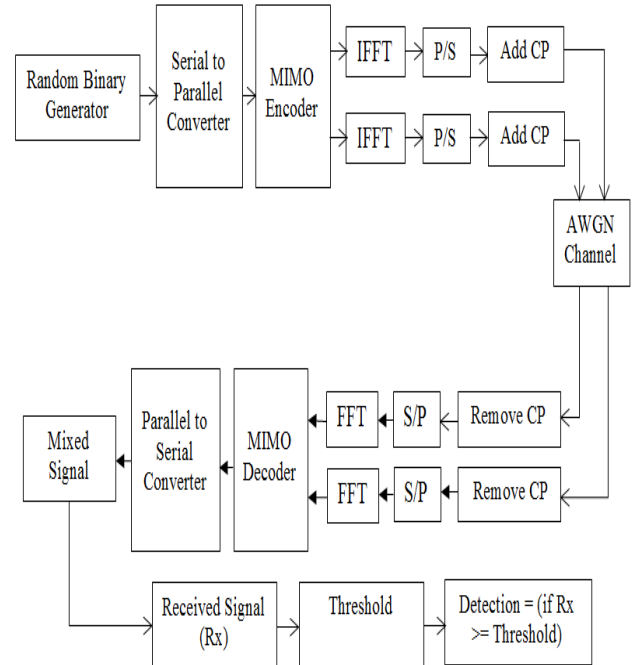

Figure 3: Design of MIMO-OFDM System using Matched Filter Spectrum Sensing Cognitive Radio Network

IV. SIMULATION RESULT

Simulation experiments are conducted to evaluate the SNR VS Bit Error Rate (BER) performance of the proposed matched filter detection spectrum sensing 8×8 system is shown in figure 4.

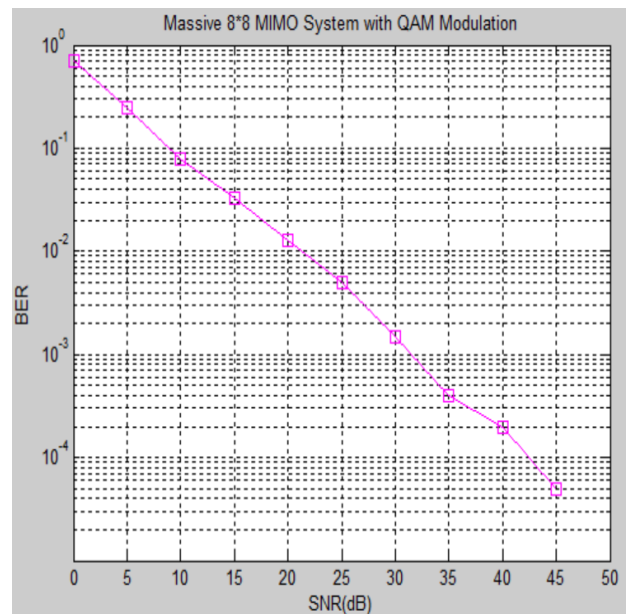

Figure 4: BER vs SNR for Matched Filter Detection Spectrum Sensing 8×8 System

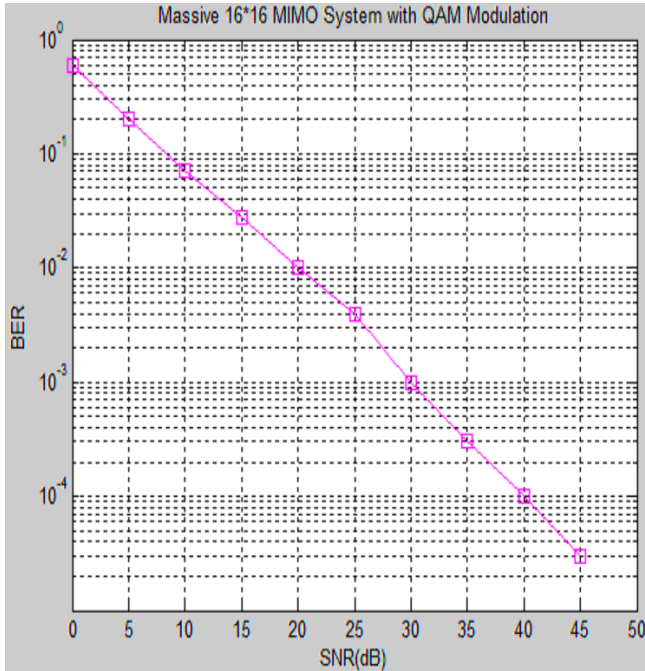

Figure 5: BER vs SNR for Matched Filter Detection Spectrum Sensing 16x16 System

Simulation experiments are conducted to evaluate the SNR VS BER performance of the proposed matched filter detection spectrum sensing 16x16 system is shown in figure 5.

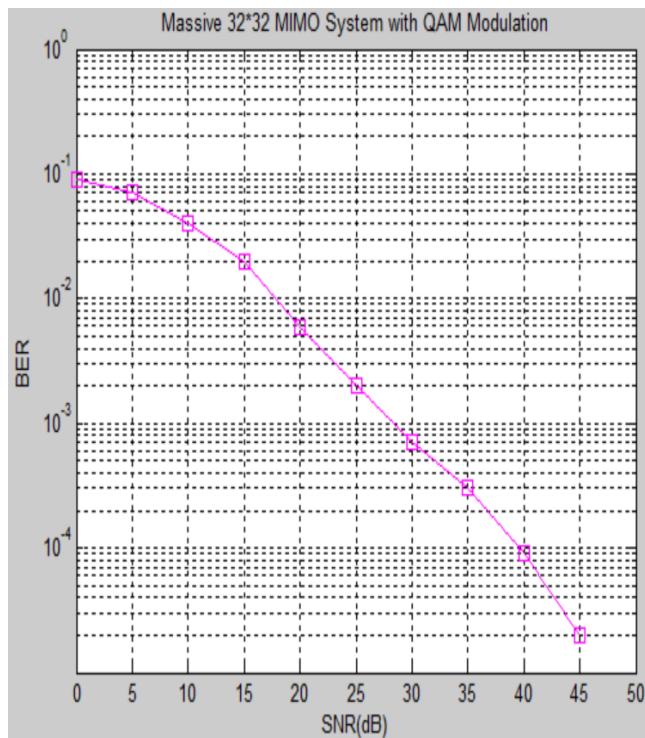

Figure 6: BER vs SNR for Matched Filter Detection Spectrum Sensing 32x32 System

Simulation experiments are conducted to evaluate the SNR VS BER performance of the proposed matched filter detection spectrum sensing 32x32 system is shown in figure 6.

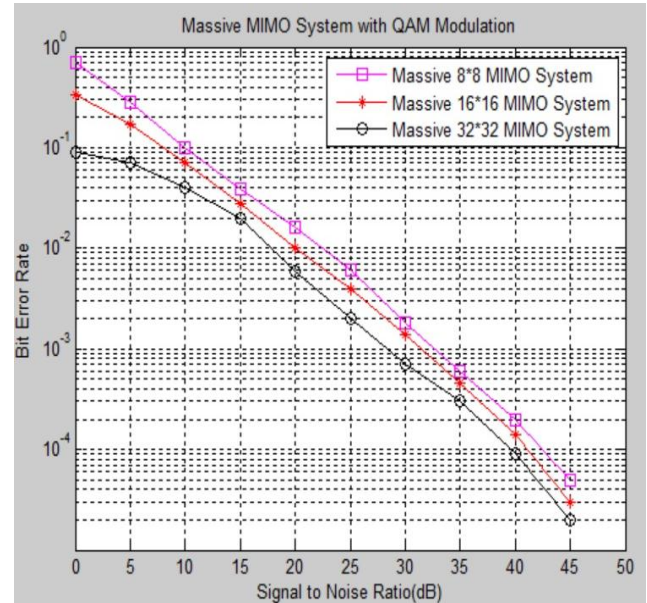

Figure 7: BER vs SNR for Matched Filter Detection Spectrum Sensing Different System

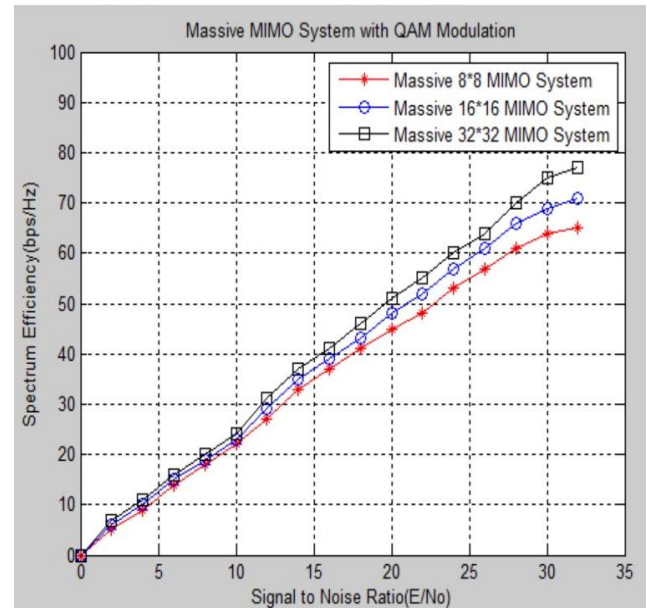

Figure 8: Spectrum Efficiency vs SNR for Matched Filter Detection Spectrum Sensing Different System

V. CONCLUSION

A matched filter, also known as optimal linear filter, is a spectrum-sensing method that detects the free portion of the primary user's spectrum and allocates it to secondary users.

It derives from cross-correlating an unknown signal with known ones to detect the unknown signal's presence based on its SNR. In matched-filter detection, the dynamic threshold is used to improve the spectrum-sensing efficiency and provide better performance in cases of lower SNR.

Wireless Communications and Networking Conference (WCNC), Applications, and Business, Vol. 27, No. 2, pp. 567-572, 2015.

REFERENCES

- [1] Supraja Eduru and Nakkeeran Rangaswamy, "BER Analysis of Massive MIMO Systems under Correlated Rayleigh Fading Channel", 9th ICCCNT IEEE 2018, IISC, Bengaluru, India.
- [2] H. Al-Hraishawi, G. Amarasuriya, and R. F. Schaefer, "Secure communication in underlay cognitive massive MIMO systems with pilot contamination," in In Proc. IEEE Global Commun. Conf. (Globecom), pp. 1–7, Dec. 2017.
- [3] V. D. Nguyen et al., "Enhancing PHY security of cooperative cognitive radio multicast communications," IEEE Trans. Cognitive Communication And Networking, vol. 3, no. 4, pp. 599–613, Dec. 2017.
- [4] R. Zhao, Y. Yuan, L. Fan, and Y. C. He, "Secrecy performance analysis of cognitive decode-and-forward relay networks in Nakagami-m fading channels," IEEE Trans. Communication, vol. 65, no. 2, pp. 549–563, Feb. 2017.
- [5] W. Zhu, J. and Xu and N. Wang, "Secure massive MIMO systems with limited RF chains," IEEE Trans. Veh. Technol., vol. 66, no. 6, pp. 5455–5460, Jun. 2017.
- [6] W. Wang, K. C. Teh, and K. H. Li, "Enhanced physical layer security in D2D spectrum sharing networks," IEEE Wireless Communication Letter, vol. 6, no. 1, pp. 106–109, Feb. 2017.
- [7] J. Zhang, G. Pan, and H. M. Wang, "On physical-layer security in underlay cognitive radio networks with full-duplex wireless-powered secondary system," IEEE Access, vol. 4, pp. 3887–3893, Jul. 2016.
- [8] R. Zhang, X. Cheng, and L. Yang, "Cooperation via spectrum sharing for physical layer security in device-to-device communications under laying cellular networks," IEEE Trans. Wireless Communication, vol. 15, no. 8, pp. 5651–5663, Aug. 2016.
- [9] K. Tourki and M. O. Hasna, "A collaboration incentive exploiting the primary-secondary systems cross interference for PHY security enhancement," IEEE J. Sel. Topics Signal Process., vol. 10, no. 8, pp. 1346–1358, Dec 2016.
- [10] T. Zhang et al., "Secure transmission in cognitive MIMO relaying networks with outdated channel state information," IEEE Access, vol. 4, pp. 8212–8224, Sep. 2016.
- [11] Y. Huang et al., "Secure transmission in spectrum sharing MIMO channels with generalized antenna selection over Nakagami-m channels," IEEE Access, vol. 4, pp. 4058–4065, Jul. 2016.
- [12] Y. Deng et al., "Artificial-noise aided secure transmission in large scale spectrum sharing networks," IEEE Trans. Communication, vol. 64, no. 5, pp. 2116–2129, May 2016.
- [13] Aparna Singh Kushwah, Monika Jain, "Performance Enhancement of MIMO-OFDM System based on Spectrum Sensing Cognitive Radio Networks using Matched Filter Detection", International Journal of Innovative Research in Computer and Communication Engineering, Vol. 6, Issue 6, June 2018.
- [14] Aparna Singh Kushwah, Alok Kumar Shukla, "BER Reduction of Distributed Spatial Modulation in Cognitive Relay Network based MIMO-OFDM System", International Journal of Innovative Research in Computer and Communication Engineering, Vol. 6, Issue 6, June 2018.
- [15] Shan Jin and Xi Zhang, "Compressive Spectrum Sensing for MIMO-OFDM Based Cognitive Radio Networks", 2015 IEEE